

DH-SD6583A-HN

3Mp Full HD Network PTZ Dome Camera



Features

- Powerful 20x optical zoom
- H.264 & MJPEG dual-stream encoding
- Max. 15fps@3Mp, 25/30fps@1080p resolution
- WDR, Day/Night(ICR), DNR (2D&3D),Auto iris, Auto focus, AWB, AGC,BLC
- Multiple network monitoring: Web viewer, CMS(DSS/PSS) & DMSS
- Max 400 °/s pan speed, 360° endless pan rotation
- Up to 255 presets, 5 auto scan, 8 tour, 5 pattern
- Built-in 7/2 alarm in/out
- Support intelligent 3D positioning with DH-SD protocol
- Micro SD memory, IP67, easy installation

DH-SD6583A-HN

Technical Specifications

Model	DH-SD6583A-HN
Camera	
Image Sensor	1/3" Exmor CMOS
Effective Pixels	2048(H) x 1536(V), 3 Megapixels
Scanning System	Progressive
Electronic Shutter Speed	1/1 ~ 1/30,000s
Min. Illumination	Color: 0.05Lux@F1.6,B/W: 0.005Lux@F1.6
S/N Ratio	More than 50dB
Video Output	BNC(1.0Vp-p/75Ω), PAL / NTSC
Camera Features	
Day/Night	Auto(ICR) / Color / B/W
Backlight Compensation	BLC / HLC / WDR
White Balance	Auto, ATW, Indoor, Outdoor, Manual
Gain Control	Auto / Manual
Noise Reduction	2D / 3D
Privacy Masking	Up to 24 areas
Digital Zoom	16x
Defog	N.A.
Lens	
Focal Length	4.7mm ~ 94.0mm(20x Optical zoom)
Max Aperture	F1.6 ~ F3.5
Focus Control	Auto / Manual
Angle of View	H: 55.4°~ 2.9°
Close Focus Distance	100mm ~ 1000mm
PTZ	
Pan/Tilt Range	Pan: 0° ~ 360° endless; Tilt: -2° ~ 90°, auto flip 180°
Manual Control Speed	Pan: 0.1° ~ 300°/s; Tilt: 0.1° ~ 250°/s
Preset Speed	Pan: 400°/s; Tilt: 300°/s
Preset	80(DH-SD), 255(Pelco-P/D)
PTZ Mode	5 Pattern, 8 Tour, Auto Pan, Auto Scan
Speed Setup	Human-oriented focal length/ speed adaptation
Power up Action	Auto restore to previous PTZ and lens status after power failure
Idle Motion	Activate Preset/Pan/Scan/Tour/Pattern if there is no command in the specified period
Time Task	Auto activation of Preset/Pan/Scan/Tour/Pattern by preset-time
Protocol	DH-SD, Pelco-P/D (Auto recognition)
Video	
Compression	H.264 / MJPEG
Resolution	3M(2048×1536)/1080P(1920×1080)/720P(1280×720)/D1(704×576/704×480)/CIF(352×288/352×240)

DH-SD6583A-HN

Frame Rate	Main Stream	3M(1~15fps)/1080P/720P(1 ~ 25/30fps)
	Sub Stream	D1/CIF(1 ~ 25/30fps)
Bit Rate		H.264: 56K ~ 8192Kbps, MJPEG: 56K ~ 20480Kbps
Audio		
Compression		G.711a / G.711u (32kbps) / PCM (128kbps)
Interface		1/1 channel In/Out
Network		
Ethernet		RJ-45 (10/100Base-T)
Protocol		IPv4/IPv6, HTTP, HTTPS, SSL, TCP/IP, UDP, UPnP, ICMP, IGMP, SNMP, RTSP, RTP, SMTP, NTP, DHCP, DNS, PPPOE, DDNS, FTP, IP Filter, QoS, Bonjour
ONVIF		ONVIF Profile S
Max. User Access		20 users
Smart Phone		iPhone, iPad, Android, Windows Phone
Auxiliary Interface		
Memory Slot		Micro SD, Max 64GB
RS485		1
Alarm		7/2 channel In/Out
General		
Power Supply		AC 24V/3A (±10%)
Power Consumption		15W, 40W(Heater on)
Working Environment		-40°C ~ 60°C / Less than 90% RH
Ingress Protection		IP67
Vandal Resistance		IK10 (optional)
Dimensions		Φ222(mm) x 322(mm)
Weight		5.0kg

DH-SD6583A-HN

Dimensions (mm)

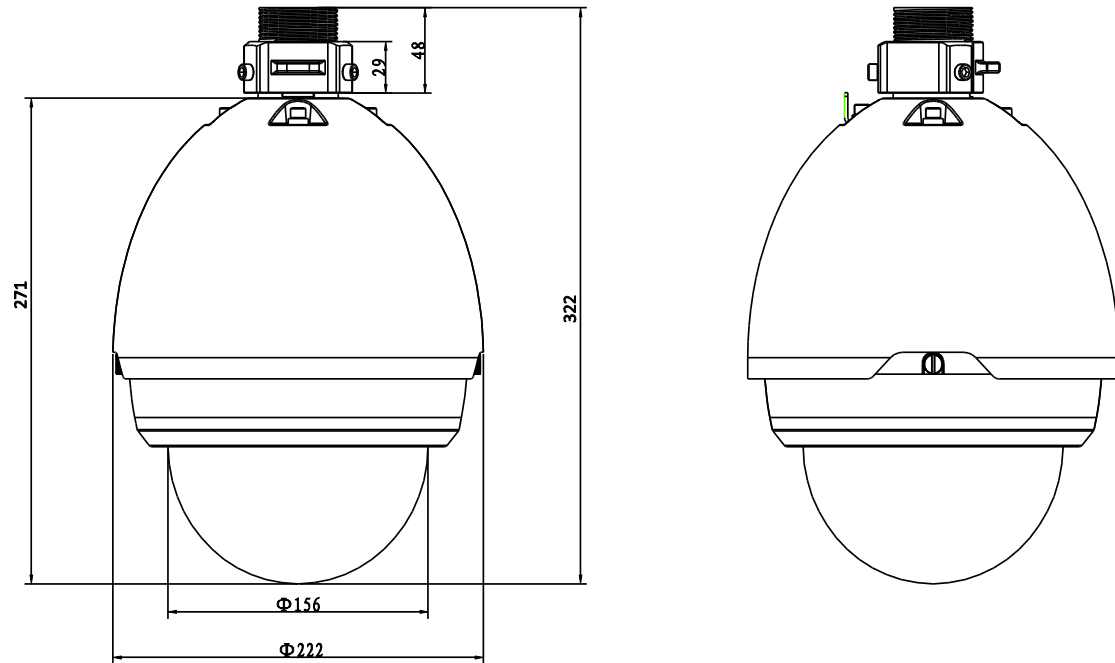









Accessories

		
DH-69FB	DH-PFA111	Power Supply

DH-SD6583A-HN

Accessories (Optional)

			
DH-PFB300C	DH- PFB301C	DH-PFA112	DH-PFA113
			
DH-PFB301S	DH-PFA120	DH-PFA150	DH-PFA151

Dahua Technology Co., Ltd.

1199 BinAn Road, Binjiang District, Hangzhou, China

Tel: +86-571-87688883

Fax: +86-571-87688815

Email: overseas@dahuatech.com

www.dahuasecurity.com

*Design and specifications are subject to change without notice.

© 2014 Dahua Technology